

GCE

Chemistry A

H032/01: Breadth in chemistry

Advanced Subsidiary GCE

Mark Scheme for June 2019

OCR (Oxford Cambridge and RSA) is a leading UK awarding body, providing a wide range of qualifications to meet the needs of candidates of all ages and abilities. OCR qualifications include AS/A Levels, Diplomas, GCSEs, Cambridge Nationals, Cambridge Technicals, Functional Skills, Key Skills, Entry Level qualifications, NVQs and vocational qualifications in areas such as IT, business, languages, teaching/training, administration and secretarial skills.

It is also responsible for developing new specifications to meet national requirements and the needs of students and teachers. OCR is a not-for-profit organisation; any surplus made is invested back into the establishment to help towards the development of qualifications and support, which keep pace with the changing needs of today's society.















This mark scheme is published as an aid to teachers and students, to indicate the requirements of the examination. It shows the basis on which marks were awarded by examiners. It does not indicate the details of the discussions which took place at an examiners' meeting before marking commenced.

All examiners are instructed that alternative correct answers and unexpected approaches in candidates' scripts must be given marks that fairly reflect the relevant knowledge and skills demonstrated.

Mark schemes should be read in conjunction with the published question papers and the report on the examination.

© OCR 2019

Annotations available in RM Assessor

Annotation	Meaning
	Correct response
	Incorrect response
	Omission mark
	Benefit of doubt given
	Contradiction
	Rounding error
	Error in number of significant figures
	Error carried forward
	Level 1
	Level 2
	Level 3
	Benefit of doubt not given
	Noted but no credit given
	Ignore

Abbreviations, annotations and conventions used in the detailed Mark Scheme (to include abbreviations and subject-specific conventions).

Annotation	Meaning
DO NOT ALLOW	Answers which are not worthy of credit
IGNORE	Statements which are irrelevant
ALLOW	Answers that can be accepted
()	Words which are not essential to gain credit
—	Underlined words must be present in answer to score a mark
ECF	Error carried forward
AW	Alternative wording
ORA	Or reverse argument

SECTION A

Question	Answer	Marks	AO element	Guidance
1	D	1	AO1.1	
2	A	1	AO1.1	
3	C	1	AO1.2	
4	D	1	AO1.2	
5	B	1	AO2.6	
6	B	1	AO2.2	
7	B	1	AO2.6	
8	D	1	AO1.2	
9	D	1	AO2.2	
10	B	1	AO1.2	
11	B	1	AO1.1	
12	C	1	AO1.1	
13	B	1	AO1.1	
14	A	1	AO1.1	
15	C	1	AO1.2	
16	A	1	AO1.1	
17	C	1	AO1.2	
18	A	1	AO2.5	
19	D	1	AO1.1	
20	B	1	AO2.5	
	Total	20		

SECTION B

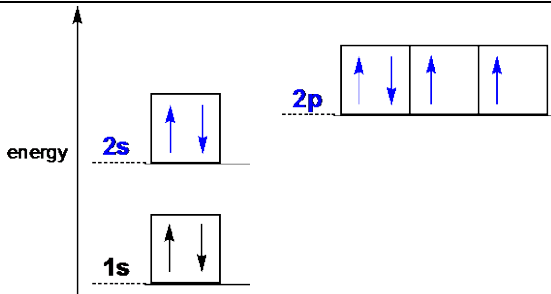
Question		Answer	Marks	AO element	Guidance																					
21	(a)	<p>TWO correct responses from ✓</p> <ul style="list-style-type: none"> Different numbers of neutrons Different (atomic) masses/mass numbers Different physical properties <p><i>Physical required</i></p>	1	AO1.1	<p>IGNORE heavier/lighter</p> <p>DO NOT ALLOW different relative atomic masses BUT ALLOW different relative isotopic masses</p> <p>DO NOT ALLOW different chemical properties OR different properties</p> <p>IGNORE different abundancies</p>																					
	(b)	<table border="1" style="margin-left: auto; margin-right: auto;"> <thead> <tr> <th>Element</th> <th>Mass number</th> <th>Protons</th> <th>Neutrons</th> <th>Electrons</th> <th>Charge</th> <th></th> </tr> </thead> <tbody> <tr> <td style="color: green;">Fe</td> <td style="color: green;">54</td> <td>26</td> <td>28</td> <td style="color: green;">26</td> <td>0</td> <td style="text-align: center;">✓</td> </tr> <tr> <td style="color: green;">Se</td> <td style="color: green;">80</td> <td style="color: green;">34</td> <td style="color: green;">46</td> <td>36</td> <td>2-</td> <td style="text-align: center;">✓</td> </tr> </tbody> </table> <p style="color: blue; margin-left: 20px;">Mark by row</p>	Element	Mass number	Protons	Neutrons	Electrons	Charge		Fe	54	26	28	26	0	✓	Se	80	34	46	36	2-	✓	2	AO1.2 ×2	<p>THREE responses for each mark <i>Easiest to check element first</i></p> <p>ALLOW Se²⁻ ALLOW names for elements</p>
Element	Mass number	Protons	Neutrons	Electrons	Charge																					
Fe	54	26	28	26	0	✓																				
Se	80	34	46	36	2-	✓																				
	(c)	<p>Sub-shells labels 2s (single box) AND 2p (3 boxes) ✓</p> <p>Electrons as arrows unpaired electrons in 3 boxes: ↑↓ ↑ ↑ AND Paired electrons in single box: ↑↓ ✓</p>	2	AO1.1 AO1.2	 <p style="text-align: center;">ALLOW single headed arrows, e.g. 1</p>																					

Question		Answer	Marks	AO element	Guidance
(d)	(i)	$3 \left[\text{Ca} \right]^{2+} \quad 2 \left[\begin{array}{ccc} \bullet & \times & \\ \times & \text{N} & \times \\ \bullet & & \bullet \end{array} \right]^{3-}$ <p>Ca shown with either 0 or 8 electrons AND N shown with 8 electrons with 5 dots and 3 crosses (or vice versa) ✓</p> <p>3 Ca AND 2 N AND correct charges on ions, i.e. $3\text{Ca}^{2+} \quad 2\text{N}^{3-}$ ✓</p> <p>Circles OR Brackets NOT required</p>	2		<p>CARE: ALLOW any pairing if electrons correct, e.g.</p> $3 \left[\text{Ca} \right]^{2+} \quad 2 \left[\begin{array}{ccc} & \times \times & \\ \bullet & \text{N} & \times \\ \bullet & & \bullet \end{array} \right]^{3-}$ <p>AO2.5</p> <p>IF 8 electrons shown around Ca, 'extra' 3 electrons around N must match symbol for Ca electrons, e.g.</p> <p>AO1.2</p> $3 \left[\begin{array}{ccc} \times \times & & \\ \times & \text{Ca} & \times \\ \times \times & & \end{array} \right]^{2+} \quad 2 \left[\begin{array}{ccc} \bullet & \times & \\ \times & \text{N} & \times \\ \bullet & & \bullet \end{array} \right]^{3-}$ <p>IGNORE inner shells</p> <p>ALLOW drawing with 3 Ca^{2+} and 2 N^{3-} e.g.</p> $\left[\text{Ca} \right]_3^{2+} \quad \left[\begin{array}{ccc} & \times \times & \\ \bullet & \text{N} & \times \\ \bullet & & \bullet \end{array} \right]_2^{3-}$
(d)	(ii)	$\text{Ca}_3\text{N}_2 + 6\text{H}_2\text{O} \rightarrow 3\text{Ca}(\text{OH})_2 + 2\text{NH}_3$ <p>$\text{Ca}(\text{OH})_2$ OR NH_3 as product ✓</p> <p>All species correct AND correct balancing ✓</p>	2	AO2.6 ×2	<p>ALLOW NH_4OH for NH_3</p> <p>ALLOW $\text{Ca}_3\text{N}_2 + 8\text{H}_2\text{O} \rightarrow 3\text{Ca}(\text{OH})_2 + 2\text{NH}_4\text{OH}$</p> <p>IGNORE other products</p>

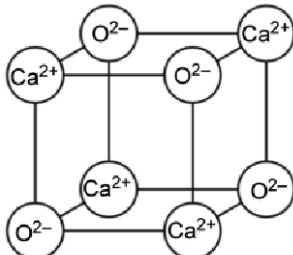
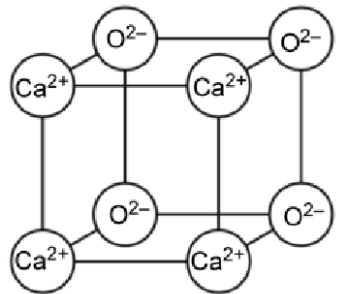
Question	Answer	Marks	AO element	Guidance
(d) (iii)	 <p>Ca²⁺ shown alternately in FOUR circles ✓</p> <p>O²⁻ shown alternately in FOUR circles ✓</p>	2	AO1.1 ×2	<p>ALLOW labels if seen outside circles provided it clear which circle the label applies to</p> <p>ALLOW 1 mark for Ca AND O shown alternately, each in FOUR circles <i>i.e. with no charges or incorrect charges</i></p> <p>ALLOW 1 mark for 2+ / +2 AND 2- / -2 shown alternately in FOUR circles (with no Ca and O)</p> <p>DO NOT ALLOW All circles with same ion, <i>i.e. all Ca²⁺ OR all O²⁻</i></p> <p>ALLOW 1 mark for 4 Ca²⁺ AND 4 O²⁻ but NOT shown alternately <i>e.g.</i></p> 

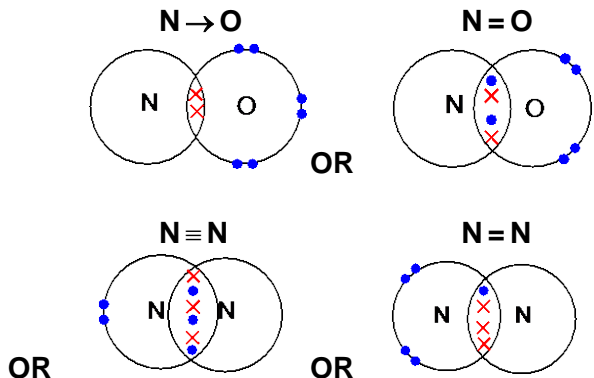
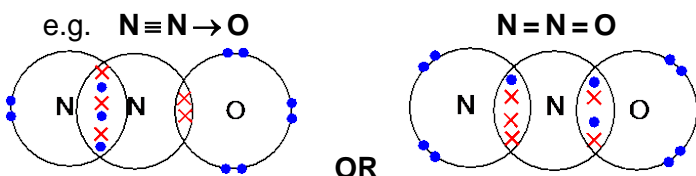
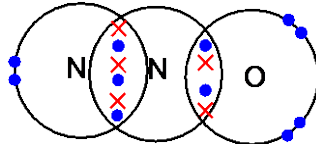
Question	Answer	Marks	AO element	Guidance
(d) (iv)	<p>'Dot and cross' of central N to O OR N ✓</p>  <p>OR</p> <hr/> <p>Rest of 'dot and cross' diagram correct ✓</p> <p>e.g. $N \equiv N \rightarrow O$ OR $N = N = O$</p> 	2	AO2.5 ×2	<p>Electrons do NOT need to be shown paired.</p> <p>'Dot and cross' of NO_2 ALLOW 1st mark for $N \rightarrow O$ OR $N = O$</p> <p>DO NOT ALLOW ions</p> <p>CARE For 2nd mark, watch for stray paired OR unpaired electrons on central N</p> <p>ALLOW 10 electrons around central N atom for 2 marks, i.e.</p> 
	Total	13		

Question			Answer	Marks	AO element	Guidance					
22	(a)	(i)	<table border="1" style="margin-left: auto; margin-right: auto;"> <tr> <td>Titre/cm³</td> <td>24.20</td> <td>23.85</td> <td>24.30</td> <td>✓</td> </tr> </table> <p>Correct subtractions to obtain titres to 2 DP</p>	Titre/cm ³	24.20	23.85	24.30	✓	2	AO2.4	DO NOT ALLOW 24.2 OR 24.3
Titre/cm ³	24.20	23.85	24.30	✓							
		(ii)	<p>mean titre = $\frac{24.20 + 22.30}{2} = 24.25 \text{ (cm}^3\text{)} \checkmark$ <i>i.e. using concordant (consistent) titres</i></p>		AO2.4	<p>DO NOT ALLOW mean of all three titres, i.e. $\frac{24.20 + 23.85 + 22.30}{3} = 24.10/24.12$</p> <p>ALLOW ECF from incorrect concordant titres from 22a(i)</p>					
	(b)		<p>FIRST CHECK THE ANSWER ON ANSWER LINE IF answer = 0.309 (mol dm⁻³) award 3 marks</p> <hr style="border-top: 1px dashed black;"/> <p>$n(\text{Na}_2\text{CO}_3)$ $= 0.150 \times \frac{25.00}{1000} = 3.75 \times 10^{-3} \text{ (mol)} \checkmark$</p> <p>$n(\text{HCl})$ $= 2 \times n(\text{Na}_2\text{CO}_3) = 7.50 \times 10^{-3} \text{ (mol)} \checkmark$</p> <p>[HCl] to 3 SF $= n(\text{HCl}) \times \frac{1000}{\text{mean titre from b(i)}}$ $= 7.50 \times 10^{-3} \times \frac{1000}{24.25} = 0.309 \text{ (mol dm}^{-3}\text{)} \checkmark$ 3 SF required</p>	3	AO2.8 ×3	<p>ALLOW 3SF or more throughout IGNORE trailing zeroes, e.g. ALLOW 0.075 for 0.00750</p> <hr style="border-top: 1px dashed black;"/> <p>ALLOW ECF from 2 × incorrect $n(\text{Na}_2\text{CO}_3)$</p> <p>ALLOW ECF from incorrect $n(\text{HCl})$, OR from $n(\text{Na}_2\text{CO}_3)$ if $n(\text{HCl})$ stage omitted</p> <p>ALLOW ECF from incorrect mean titre in b(ii)</p> <hr style="border-top: 1px dashed black;"/> <p>COMMON ERROR for 3 marks From 24.10 cm³ (mean of all 3 titres in b(ii)), [HCl] = 0.311 (mol dm⁻³)</p>					

Question		Answer	Marks	AO element	Guidance
	(c)	<p>Pipette: $\frac{0.04}{25.0} \times 100 = 0.16$ OR 0.2 (%) ✓</p> <p>Burette: (using any of 3 titres or mean titre), e.g. $\frac{0.05 \times 2}{24.20} \times 100 = 0.41$ OR 0.4 (%) ✓</p> <p>Response does NOT need a statement of whether pipette or burette has greater % uncertainty.</p>	2	AO3.1 ×2	<p>ALLOW % uncertainties to 1 SF or more, rounded correctly</p> <p>-----</p> <p>Other burette volumes:</p> $\frac{0.05 \times 2}{23.85} \times 100 = 0.42$ OR 0.4 (%) $\frac{0.05 \times 2}{24.30} \times 100 = 0.41$ OR 0.4 (%) $\frac{0.05 \times 2}{24.25} \times 100 = 0.41$ OR 0.4 (%) <p>ALLOW burette volume of 50 cm³, i.e. $\frac{0.05 \times 2}{50} \times 100 = 0.2\%$</p> <p>ALLOW ECF from incorrect titre in 22(a)</p> <p>IF BOTH calculations are 'correct' but ×100 is omitted BOTH times, ALLOW 1 mark</p>
		Total	7		

Question		Answer	Marks	AO element	Guidance
23	(a)	<p>Electrons (down group) number of electrons increases ✓</p> <p>Type of intermolecular force (ANYWHERE) induced dipole(–dipole) interactions OR London forces ✓</p> <p>Link of energy with intermolecular forces (ANYWHERE) (Down group,) more energy to break/overcome intermolecular forces OR more/stronger intermolecular forces ✓</p>	3	AO1.1 ×3	<p><i>FULL ANNOTATIONS MUST BE USED</i></p> <hr style="border-top: 1px dashed blue;"/> <p>ALLOW more electron shells</p> <p>IGNORE ‘more shells’ OR more (electron) shielding</p> <p>IGNORE comments about nuclear attraction, ionisation energy, etc.</p> <p>IGNORE van der Waals’ forces, vdw IGNORE abbreviations e.g. LDF, IDID</p> <p>IGNORE less energy needed to break ‘bonds’ OR less energy needed to break ‘London forces’ <i>Too vague – needs idea of ‘between molecules’</i></p> <p>IGNORE ‘covalent bonds’ <i>between atoms</i> BUT response linking to breaking of covalent bonds is a CON for last marking point ONLY.</p>

Question	Answer	Marks	AO element	Guidance
(b)	<p>Test for Br⁻ (anion) 2 marks</p> <p><i>Reagent AND observation</i> Silver nitrate/AgNO₃ AND cream (precipitate) ✓</p> <p><i>Equation</i> $\text{Ag}^+ + \text{Br}^- \rightarrow \text{AgBr}$ ✓ <i>State symbols not required</i></p> <hr/> <p>Test for NH₄⁺ (cation) 3 marks</p> <p><i>Reagent and conditions</i> (Heat with) NaOH/KOH/Ca(OH)₂/OH⁻/hydroxide BUT NOT ammonia ✓</p> <p><i>Observation (Independent mark)</i> pH/indicator paper turns blue / purple / alkaline ✓</p> <p><i>Equation</i> $\text{NH}_4^+ + \text{OH}^- \rightarrow \text{NH}_3 + \text{H}_2\text{O}$ ✓ <i>State symbols not required</i></p>	5	AO3.3 ×5	<p>FULL ANNOTATIONS WITH TICKS, CROSSES, CON, etc. MUST BE USED</p> <hr/> <p>IGNORE confusion between <i>cation</i> and <i>anion</i> IGNORE nitric acid ALLOW 'bromine' for bromide in text</p> <p>IGNORE responses about solubility in NH₃</p> <p>ALLOW full equation: e.g. $\text{AgNO}_3 + \text{NH}_4\text{Br} \rightarrow \text{AgBr} + \text{NH}_4\text{NO}_3$</p> <hr/> <p>ALLOW displacement by Cl₂</p> <p><i>Reagent</i> Cl₂/chlorine AND <i>Observation</i> Orange (solution) ✓ ALLOW shade of orange DO NOT ALLOW precipitate</p> <p><i>Equation</i> $2\text{Br}^- + \text{Cl}_2 \rightarrow \text{Br}_2 + 2\text{Cl}^-$ ✓ ALLOW full equation, e.g. $2\text{NaBr} + \text{Cl}_2 \rightarrow \text{Br}_2 + 2\text{NaCl}$</p> <hr/> <p>ALLOW full equation: i.e. $\text{NH}_4\text{Br} + \text{NaOH} \rightarrow \text{NaBr} + \text{NH}_3 + \text{H}_2\text{O}$</p> <p>ALLOW $\text{NH}_4\text{Br} + \text{NaOH} \rightarrow \text{NaBr} + \text{NH}_4\text{OH}$</p>
	Total	8		

Question			Answer	Marks	AO element	Guidance
24	(a)	(i)	<p>Pressure: Right-hand side has fewer (gaseous) moles OR 4 (gaseous) moles form 2 (gaseous) moles ✓</p> <p>High pressure ✓</p> <p>Temperature: (Forward) reaction is exothermic/ΔH is negative OR (Forward) reaction gives out heat ✓</p> <p>Low temperature ✓</p>	4		<p><i>FULL ANNOTATIONS MUST BE USED</i></p> <hr style="border-top: 1px dashed blue;"/> <p>ALLOW suitable alternatives for right-hand side, e.g.: towards NH_3/products OR forward direction OR increases yield</p> <p>AO1.2 For moles, ALLOW molecules/particles</p> <p>AO2.1</p> <p>AO1.2 ALLOW reverse reaction is endothermic /ΔH is positive/takes in heat</p> <p>AO2.1 ORA for reverse reaction</p>
		(ii)	<p>FIRST CHECK THE ANSWER ON ANSWER LINE IF answer = 2.86×10^{-2} award 2 marks</p> <hr style="border-top: 1px dashed black;"/> <p>K_c expression $(K_c =) \frac{[\text{NH}_3]^2}{[\text{N}_2][\text{H}_2]^3}$ OR $\frac{0.862^2}{1.25 \times 2.75^3}$ OR 0.02858 ✓</p> <p>Answer to 3 SF and in standard form $K_c = 2.86 \times 10^{-2}$ ✓</p>	2	AO2.6 ×2	<p>IF there is an alternative answer, check for any ECF credit possible using working below.</p> <hr style="border-top: 1px dashed black;"/> <p>ALLOW calculated value 0.02858291 correctly rounded to 3 or more SF for 1st marking point</p> <p>ALLOW ECF to 3 SF and standard form ONLY from inverted K_c expression $\rightarrow 3.50 \times 10^1$</p> <p>DO NOT ALLOW $\frac{[\text{NH}_3]^2}{[\text{N}_2] + [\text{H}_2]^3} = 0.0337$ (no marks)</p> <p>IGNORE attempts at units</p>

Question		Answer	Marks	AO element	Guidance
	(b) (i)	298 K/25°C AND 100 kPa ✓	1	AO1.1	ALLOW 'a stated temperature' <i>To accept that other standard temperatures can be used and 298 should strictly be added as ΔH_{298}^{\ominus}</i> ALLOW 1×10^5 Pa, 101 kPa, 1.01×10^5 Pa, 1 atm, 1 bar
	(ii)	FIRST, CHECK THE ANSWER ON ANSWER LINE IF answer = (+)90 (kJ mol⁻¹) award 3 marks IF answer = -90 (kJ mol⁻¹) award 2 marks IF answer = (+)360 (kJ mol⁻¹) award 2 marks ----- Use of $\Delta_f H$ values and balancing numbers $\pm (4 \times -46)$ OR ± 184 AND $\pm (6 \times -242)$ OR ± 1452 seen anywhere ✓ Correct subtraction using $\Delta H = -908$ $4 \times \Delta_f H(\text{NO})$ $= (4 \times -46) - (6 \times -242) - 908$ $= -184 + 1452 - 908$ $= (+)360 \text{ (kJ mol}^{-1}\text{)} \checkmark$ Calculation of $\Delta_f H(\text{NO})$ formation by $\div 4$ $\Delta_f H(\text{NO}) = \frac{360}{4} = (+)90 \text{ (kJ mol}^{-1}\text{)} \checkmark$	3	AO2.6 $\times 3$	FULL ANNOTATIONS MUST BE USED ALLOW ECF if common errors not seen IF ΔH of -908 has NOT been used, ONLY award 1st mark ----- COMMON ERRORS 1 mark Incorrect signs(s) AND missing $\div 4$ ± 2544 from $\pm (184 + 1452 + 908)$ ± 728 from $\pm (184 + 1452 - 908)$ ± 2176 from $\pm (-184 + 1452 + 908)$ -360 from $-(-184 + 1452 - 908)$ 2 marks Incorrect signs(s) ± 636 from $\pm (184 + 1452 + 908) = \pm 2544 \div 4$ ± 182 from $\pm (184 + 1452 - 908) = \pm 728 \div 4$ ± 544 from $\pm (-184 + 1452 + 908) = \pm 2176 \div 4$ -90 from $-(-184 + 1452 - 908) = -360 \div 4$
Total			10		

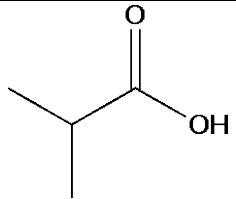
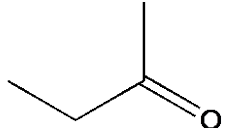
Question			Answer	Marks	AO element	Guidance
25	(a)	(i)	<p>A → </p> <p>B → NONE</p> <p>C → </p>	3	AO2.5 AO1.2 AO2.5	<p>ALLOW any combination of skeletal OR structural OR displayed formula as long as unambiguous</p> <p>DO NOT ALLOW STICKS IN STRUCTURES</p>
		(ii)	butan-2-ol ✓	1	AO1.2	<p>IGNORE lack of hyphens, or addition of commas</p> <p>ALLOW butane-2-ol</p> <p>DO NOT ALLOW butan-3-ol OR but-2-ol</p>
		(iii)	$C_4H_{10}O + 6O_2 \rightarrow 4CO_2 + 5H_2O$ ✓	1	AO2.6	

Question		Answer	Marks	AO element	Guidance
	(b) (i)	<p>Initiation $\text{Cl}_2 \rightarrow 2\text{Cl}\cdot$ AND UV ✓</p> <p>Propagation $\text{C}_4\text{H}_{10} + \text{Cl}\cdot \rightarrow \text{C}_4\text{H}_9\cdot + \text{HCl}$ ✓</p> <p>$\text{C}_4\text{H}_9\cdot + \text{Cl}_2 \rightarrow \text{C}_4\text{H}_9\text{Cl} + \text{Cl}\cdot$ ✓</p>	3	AO1.1 AO2.5 AO2.5	<p>Dots NOT required for initiation IGNORE temperature OR pressure</p> <p>Dots required in each propagation equation</p> <p>ALLOW 1 mark for BOTH propagation equations with any dots missing or extra dots e.g. $\text{C}_4\text{H}_{10} + \text{Cl} \rightarrow \text{C}_4\text{H}_9 + \text{HCl}$ $\text{C}_4\text{H}_9\cdot + \text{Cl}_2\cdot \rightarrow \text{C}_4\text{H}_9\text{Cl} + \text{Cl}$</p> <p>DO NOT ALLOW charges</p>
	(ii)	$\text{C}_4\text{H}_{10} + 10 \text{Cl}_2 \rightarrow \text{C}_4\text{Cl}_{10} + 10 \text{HCl}$ ✓	1	AO2.6	<p>ALLOW structural formulae, e.g. $\text{CH}_3\text{CH}_2\text{CH}_2\text{CH}_3 + 10\text{Cl}_2$ $\rightarrow \text{CCl}_3\text{CCl}_2\text{CCl}_2\text{CCl}_3 + 10\text{HCl}$</p>
	(iii)	<p>$n(\text{E}) = \frac{78.0}{32500} = 2.4(0) \times 10^{-3}$ (mol) ✓</p> <p>$M(\text{E}) = \frac{0.636}{2.4(0) \times 10^{-3}}$ OR 265 ✓</p> <p>Molecular formula = $\text{C}_4\text{H}_4\text{Cl}_6$ ✓</p>	3	AO3.1 ×2 AO3.2	<p>ALLOW ECF from incorrect $n(\text{E})$</p> <p>ALLOW ECF from incorrect $M(\text{E})$ from $n(\text{E})$</p> <p>-----</p> <p>COMMON ERROR</p> <p>$n(\text{E}) = \frac{78.0}{24000} = 3.25 \times 10^{-3}$ (mol) ✗</p> <p>$M(\text{E}) = \frac{0.636}{3.25 \times 10^{-3}} = 195.69$ OR 196 ✓</p> <p>(3SF or more)</p> <p>Molecular formula = $\text{C}_4\text{H}_6\text{Cl}_4$ ✓</p> <p>ALLOW ECF for molecular formula but must be derived from a calculated value for $M(\text{E})$</p>
		Total	12		

OCR (Oxford Cambridge and RSA Examinations)
The Triangle Building
Shaftesbury Road
Cambridge
CB2 8EA

OCR Customer Contact Centre

Education and Learning

Telephone: 01223 553998

Facsimile: 01223 552627

Email: general.qualifications@ocr.org.uk

www.ocr.org.uk

For staff training purposes and as part of our quality assurance programme your call may be recorded or monitored

Oxford Cambridge and RSA Examinations
is a Company Limited by Guarantee
Registered in England
Registered Office; The Triangle Building, Shaftesbury Road, Cambridge, CB2 8EA
Registered Company Number: 3484466
OCR is an exempt Charity

OCR (Oxford Cambridge and RSA Examinations)
Head office
Telephone: 01223 552552
Facsimile: 01223 552553

© OCR 2019

