

Write your name here

Surname

Other names

Centre Number

Candidate Number

Edexcel GCE

Physics

**Advanced Subsidiary
Unit 2: Physics at Work**

Friday 25 May 2012 – Afternoon
Time: 1 hour 30 minutes

Paper Reference

6PH02/01

You do not need any other materials.

Total Marks

Instructions

- Use **black** ink or ball-point pen.
- **Fill in the boxes** at the top of this page with your name, centre number and candidate number.
- Answer **all** questions.
- Answer the questions in the spaces provided – *there may be more space than you need.*

Information

- The total mark for this paper is 80.
- The marks for **each** question are shown in brackets – *use this as a guide as to how much time to spend on each question.*
- Questions labelled with an **asterisk** (*) are ones where the quality of your written communication will be assessed – *you should take particular care with your spelling, punctuation and grammar, as well as the clarity of expression, on these questions.*
- The list of data, formulae and relationships is printed at the end of this booklet.
- Candidates may use a scientific calculator.

Advice

- Read each question carefully before you start to answer it.
- Keep an eye on the time.
- Try to answer every question.
- Check your answers if you have time at the end.

Turn over ►

P39854A

©2012 Pearson Education Ltd.

1/1/1/C2/



PEARSON

SECTION A

Answer ALL questions.

For questions 1–10, in Section A, select one answer from A to D and put a cross in the box . If you change your mind, put a line through the box and then mark your new answer with a cross .

1 The resistance of a negative temperature coefficient thermistor

- A becomes zero above a certain temperature.
- B decreases as the temperature decreases.
- C increases as the temperature decreases.
- D is constant at temperatures below 0 °C.

(Total for Question 1 = 1 mark)

2 Compared to ultraviolet radiation, gamma radiation has

- A a higher frequency and a longer wavelength.
- B a higher frequency and a shorter wavelength.
- C a lower frequency and a longer wavelength.
- D a lower frequency and a shorter wavelength.

(Total for Question 2 = 1 mark)



- 3 A ray of light is incident on a thin film of oil on water. Some of the light is reflected at X and some at Y.

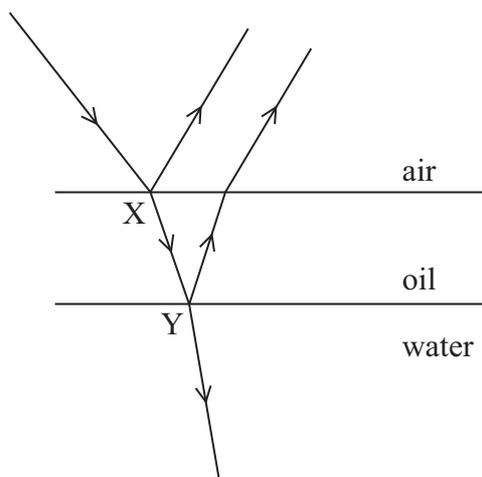

The two reflected rays will be 180° out of phase if the path difference is

- A an odd number of wavelengths.
- B an even number of wavelengths.
- C an odd number of half wavelengths.
- D an even number of half wavelengths.

(Total for Question 3 = 1 mark)



- 4 The graphs show the variation of potential difference V with the current I for three components.

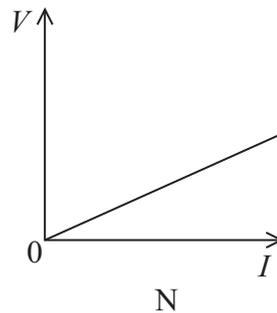
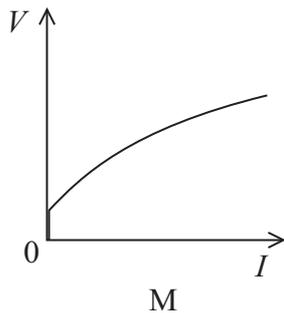
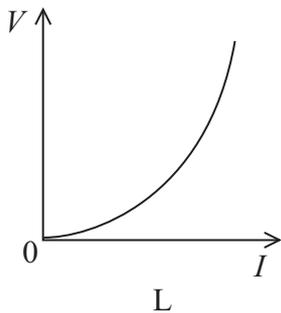

The three components are a metal wire at constant temperature, a filament lamp and a diode.

Which row of the table correctly identifies these graphs?

	Metal wire at constant temperature	Filament lamp	Diode
<input type="checkbox"/> A	L	M	N
<input type="checkbox"/> B	L	N	M
<input type="checkbox"/> C	N	M	L
<input type="checkbox"/> D	N	L	M

(Total for Question 4 = 1 mark)



5 The graphs show possible variations of power P with potential difference V .

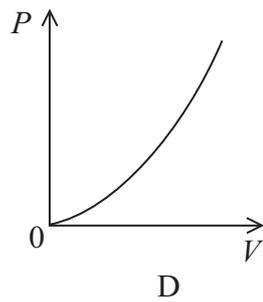
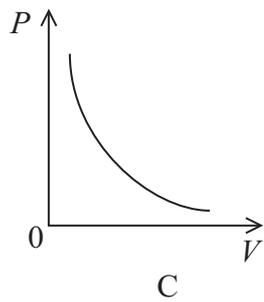
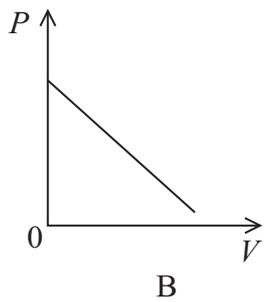
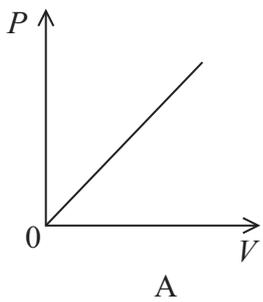

Which graph is correct for a resistor that obeys Ohm's law?

- A
- B
- C
- D

(Total for Question 5 = 1 mark)

6 Which combination of resistors has the smallest total resistance?

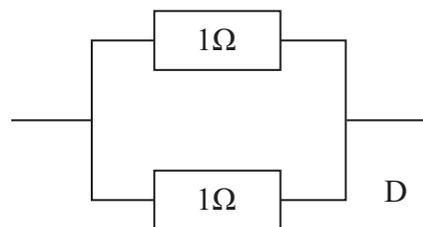
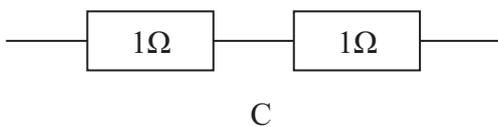
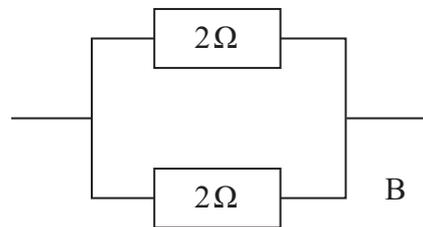
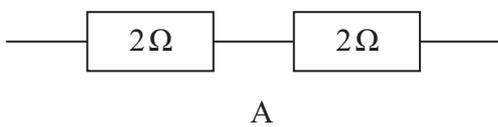

- A
- B
- C
- D

(Total for Question 6 = 1 mark)



Use the following diagram to answer Questions 7 and 8

The diagram represents a longitudinal wave moving to the right through a uniform medium.

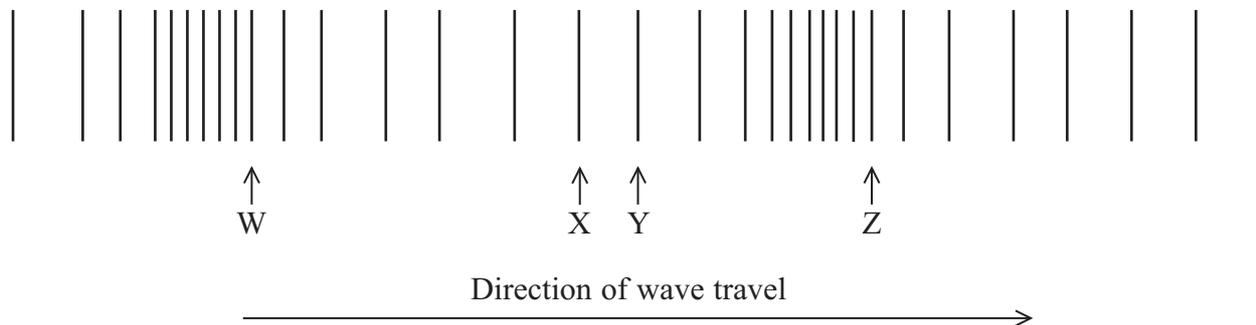

Points W, X, Y and Z represent the positions of particles of the medium.

7 The motion of the particle at W is represented by

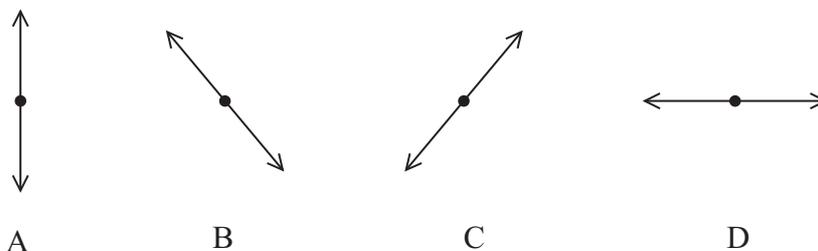

- A
- B
- C
- D

(Total for Question 7 = 1 mark)

8 The wavelength of the wave shown is the distance between points

- A W and Y.
- B W and Z.
- C X and Y.
- D Y and Z.

(Total for Question 8 = 1 mark)



- 9 Two wires of the same material are connected in series with a potential difference across them. Wire A has twice the cross-sectional area of wire B.

The ratio $\frac{\text{drift speed of electrons in A}}{\text{drift speed of electrons in B}}$ equals

- A $\frac{1}{4}$
- B $\frac{1}{2}$
- C 2
- D 4

(Total for Question 9 = 1 mark)

- 10 A student investigates how the resistance of a filament lamp varies during the first second after it is switched on.

He decides to use a computer with data logging sensors to take the readings.

The best reason for this is that

- A a large number of readings can be taken.
- B the computer can calculate the resistance.
- C there is no human error.
- D there is no zero error.

(Total for Question 10 = 1 mark)

TOTAL FOR SECTION A = 10 MARKS



SECTION B

Answer ALL questions in the spaces provided.

- 11 The photograph shows a convector heater designed for use in a home. It operates by air flowing through the heater and passing over its heating elements.



The heater contains three identical heating elements and two switches.

- (a) A student models the heater using the circuit below. The power supply has a negligible internal resistance.

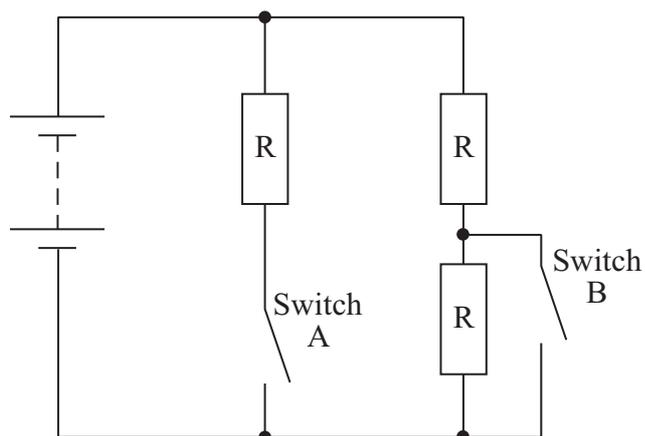

The table gives the four possible combinations of the two switches.
Complete the table to show the total circuit resistance for each switch combination.

(3)

Switch combinations	Total circuit resistance
A open. B closed	R
A open. B open	
A closed. B closed	
A closed. B open	

(b) Explain which switch combination dissipates the most energy in a given time.

(2)

.....

.....

.....

.....

(c) The power supply is replaced by one with an internal resistance.

Explain what effect this change will have on the thermal energy output of the heater.

(2)

.....

.....

.....

.....

.....

(Total for Question 11 = 7 marks)



BLANK PAGE



12 Monochromatic light is shone onto the surface of a clean metal plate. The photoelectric effect results in electrons being emitted from the surface.

(a) State and explain the effect on the emitted electrons if

(i) the frequency of the light is increased

(2)

.....

.....

.....

(ii) the intensity of the light is increased.

(2)

.....

.....

.....

***(b)** Explain how the photoelectric effect supports the particle model of light and not the wave model of light.

(4)

.....

.....

.....

.....

.....

.....

.....

.....

.....

.....

.....

(Total for Question 12 = 8 marks)



13 The photograph shows a typical hairdryer.



- (a) The hairdryer contains a heating element which consists of a long nichrome wire wound around an insulator. The heating element operates at 230 V and has a power rating of 1 kW.

Show that the resistance of the heating element is about 50Ω .

(3)

.....

.....

.....

.....

.....

.....

- (b) The nichrome wire has a cross-sectional area of $1.3 \times 10^{-7} \text{ m}^2$.

Calculate the length of the wire.

resistivity of nichrome = $1.1 \times 10^{-6} \Omega \text{ m}$

(2)

.....

.....

.....

.....

.....

Length =



(c) The nichrome wire has a diameter of 0.40 mm. A manufacturer wishes to make a hairdryer of the same resistance but using half the length of wire.

Calculate the diameter of nichrome wire that must be used.

(3)

.....

.....

.....

.....

.....

.....

.....

Diameter =

(Total for Question 13 = 8 marks)



14 The diagram shows the main components of a fluorescent light tube.

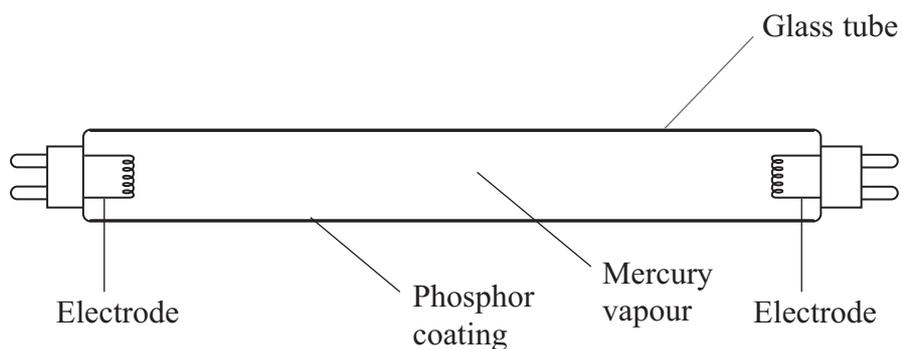

When the light is switched on, charge flows between the electrodes and the mercury atoms become excited. The mercury atoms then emit electromagnetic radiation.

(a) What is meant by *the mercury atoms become excited*?

(2)

.....

.....

.....

.....



(b) (i) Explain how the excited atoms emit radiation.

(2)

.....

.....

.....

(ii) Explain why only certain frequencies of radiation are emitted.

(3)

.....

.....

.....

.....

.....

.....

.....

.....

(iii) Some of the radiation is ultraviolet radiation which the human eye cannot detect.
The phosphor coating absorbs the ultraviolet radiation and emits visible light.

Suggest why the phosphor coating emits different wavelengths from the mercury.

(1)

.....

.....

.....

(Total for Question 14 = 8 marks)



15 The photograph shows the image of a fetus inside its mother's uterus. Ultrasound was used to produce this image.



(a) Explain how ultrasound pulses can be used to build up the image of the fetus in the uterus.

(3)

.....

.....

.....

.....

.....

.....

(b) Explain how the Doppler effect is used to detect the heartbeat of the fetus.

(2)

.....

.....

.....

.....

.....

.....



(c) The smallest detail that can be seen on the image is half the length of the ultrasound pulse. The thumbnail on the fetus is 0.50 mm thick. The speed of ultrasound in the thumbnail is 2000 m s^{-1} .

Calculate the maximum pulse duration if the thumbnail is to be seen on the image.

(3)

.....

.....

.....

.....

.....

.....

.....

Maximum pulse duration =

(Total for Question 15 = 8 marks)



16 (a) State what is meant by diffraction.

(2)

.....

.....

.....

(b) State the principle of superposition of waves.

(2)

.....

.....

.....

*(c) The photograph shows a beach in England. Waves can be seen passing rocks on their way to the beach. The uneven surface of the sand has formed as a result of diffraction and superposition of these waves.

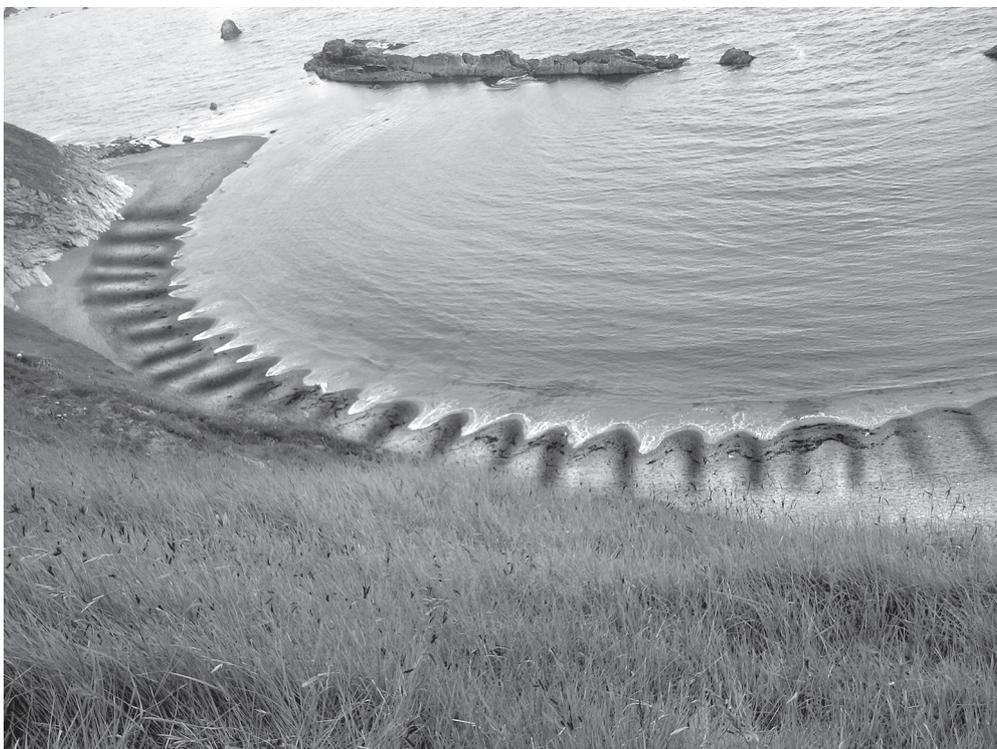

17 Rainbows are seen when sunlight is dispersed by raindrops. The light is separated into different colours because they each take different paths through raindrops.

A ray of white light is incident on a raindrop. The diagram shows the subsequent path of the red light.

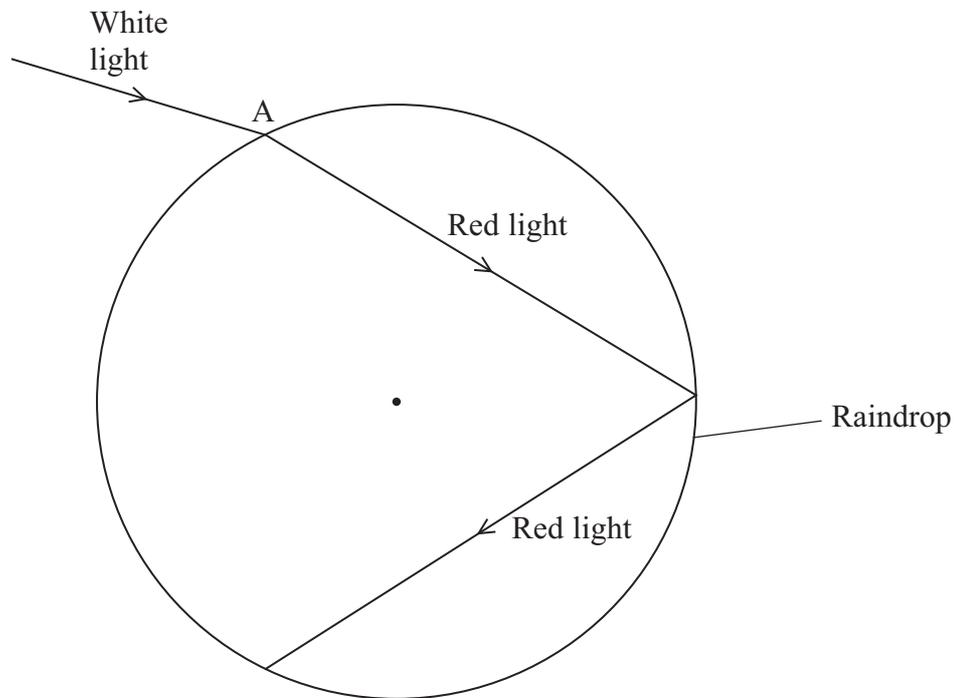

(a) Name the effect that is experienced by the red light at A.

(1)

(b) (i) On the diagram label an angle of incidence with an i and an angle of refraction with an r .

(2)

(ii) On the diagram draw the path that a violet ray of light would take, through the raindrop and into the air.

(2)



(c) (i) State what is meant by the critical angle.

(1)

(ii) Calculate the critical angle for red light in the raindrop.

refractive index for red light in water = 1.3

(2)

Critical angle =

(d) Red light has a frequency of 4.2×10^{14} Hz and travels at a speed of 2.2×10^8 m s⁻¹ in the raindrop.

Calculate the wavelength of the red light in the raindrop.

(2)

Wavelength =

(Total for Question 17 = 10 marks)



18 A 'flat' car battery of internal resistance 0.050Ω is charged with a battery charger. The battery charger consists of a power supply (with negligible internal resistance) of e.m.f. 15 V in series with a resistor of resistance 0.65Ω .

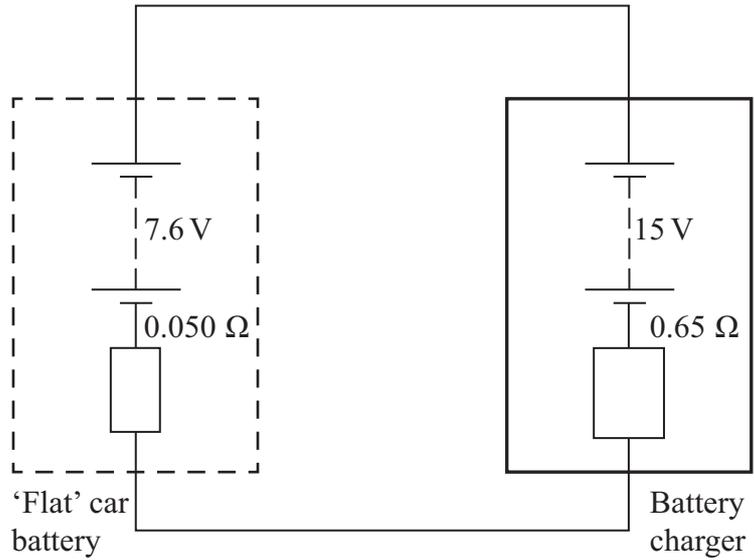

The positive terminal of the car battery is connected to the positive terminal of the battery charger.

(a) (i) Determine the resultant e.m.f. of the circuit. (1)

.....

.....

Resultant e.m.f. =

(ii) Determine the total resistance of the circuit. (1)

.....

.....

Total resistance =

(iii) Calculate the initial charging current. (2)

.....

.....

.....

Charging current =



(b) The e.m.f. of the car battery quickly increases to 12.0 V and the charging current becomes 4.30 A.

(i) Show that the terminal potential difference across the battery charger is now about 12 V.

(3)

.....

.....

.....

.....

.....

.....

(ii) Calculate the rate at which electrical energy is now being supplied by the 15 V power supply.

(2)

.....

.....

.....

.....

Rate of energy supply =

(iii) The wasted energy in this process is the energy dissipated in the internal resistance of the car battery and the series resistor in the battery charger.

Calculate the efficiency of the charging process when the current is 4.30 A.

(3)

.....

.....

.....

.....

.....

.....

Efficiency =

(Total for Question 18 = 12 marks)

TOTAL FOR SECTION B = 70 MARKS

TOTAL FOR PAPER = 80 MARKS



List of data, formulae and relationships

Acceleration of free fall	$g = 9.81 \text{ m s}^{-2}$	(close to Earth's surface)
Electron charge	$e = -1.60 \times 10^{-19} \text{ C}$	
Electron mass	$m_e = 9.11 \times 10^{-31} \text{ kg}$	
Electronvolt	$1 \text{ eV} = 1.60 \times 10^{-19} \text{ J}$	
Gravitational field strength	$g = 9.81 \text{ N kg}^{-1}$	(close to Earth's surface)
Planck constant	$h = 6.63 \times 10^{-34} \text{ J s}$	
Speed of light in a vacuum	$c = 3.00 \times 10^8 \text{ m s}^{-1}$	

Unit 1

Mechanics

Kinematic equations of motion	$v = u + at$ $s = ut + \frac{1}{2}at^2$ $v^2 = u^2 + 2as$
Forces	$\Sigma F = ma$ $g = F/m$ $W = mg$
Work and energy	$\Delta W = F\Delta s$ $E_k = \frac{1}{2}mv^2$ $\Delta E_{\text{grav}} = mg\Delta h$

Materials

Stokes' law	$F = 6\pi\eta r v$
Hooke's law	$F = k\Delta x$
Density	$\rho = m/V$
Pressure	$p = F/A$
Young modulus	$E = \sigma/\epsilon$ where Stress $\sigma = F/A$ Strain $\epsilon = \Delta x/x$
Elastic strain energy	$E_{\text{el}} = \frac{1}{2}F\Delta x$



Unit 2

Waves

Wave speed $v = f\lambda$

Refractive index ${}_1\mu_2 = \sin i / \sin r = v_1/v_2$

Electricity

Potential difference $V = W/Q$

Resistance $R = V/I$

Electrical power, energy and efficiency

$$P = VI$$
$$P = I^2R$$
$$P = V^2/R$$
$$W = VI t$$

$$\% \text{ efficiency} = \frac{\text{useful energy output}}{\text{total energy input}} \times 100$$

$$\% \text{ efficiency} = \frac{\text{useful power output}}{\text{total power input}} \times 100$$

Resistivity $R = \rho l/A$

Current

$$I = \Delta Q / \Delta t$$
$$I = nqvA$$

Resistors in series $R = R_1 + R_2 + R_3$

Resistors in parallel $\frac{1}{R} = \frac{1}{R_1} + \frac{1}{R_2} + \frac{1}{R_3}$

Quantum physics

Photon model $E = hf$

Einstein's photoelectric equation $hf = \phi + \frac{1}{2}mv_{\max}^2$



BLANK PAGE



BLANK PAGE



BLANK PAGE

